

8200

Profilo gola sottotop
con guarnizione di battuta

Gola profile with gasket

M A

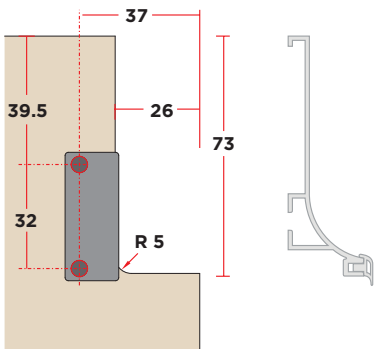
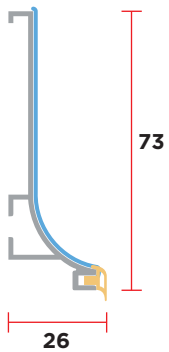

CODE	UNIT	DIMENSION	MIN ORDER QTY	PCS/BOX	BOX SIZES	WEIGHT	VOLUME
		L	ML	NR	L X B X H	KG	M ³
8200xxx01L39	ML	3900	78	20	BOX07 4050x110x205	35,50	0,091

SU101A

Supporti attacco a vite

Screw fixing support

CHIEDERE AL CUSTOMER SERVICE
LA SPECIFICA DI LAVORAZIONE
ASK CUSTOMER SERVICE
FOR THE PROCESSING DETAILS

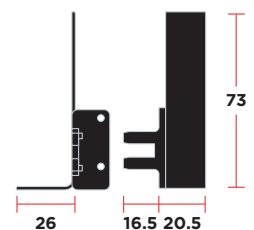
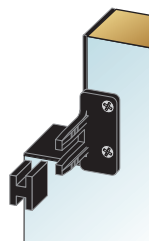

CODE	UNIT	DIMENSION	MIN ORDER QTY	PCS/BOX	BOX SIZES	WEIGHT	VOLUME
			NR	NR	L X B X H	KG	M ³
SU101ADS06000	CP	-	700	700	BOX57PB 500x400x300	4,90	0,060

SU116



Supporto rapido attacco a vite

Screw fixing quick support

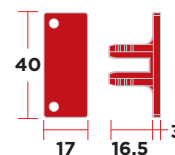
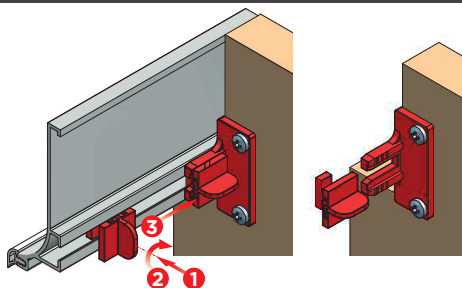

CODE	UNIT	DIMENSION	MIN ORDER QTY	PCS/BOX	BOX SIZES	WEIGHT	VOLUME
			NR	NR	L X B X H	KG	M ³
SU116DS590000	CP	-	300	300	BOX01PB 400x300x200	3,30	0,024

SU136



Supporto rapido con pioli

Pins fixing quick support

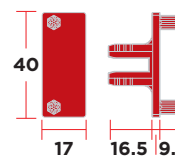
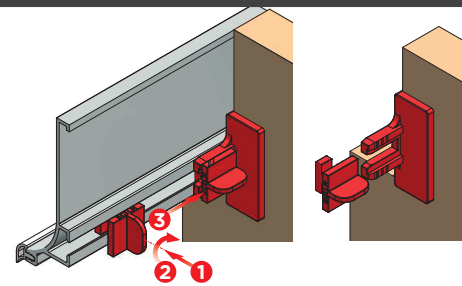

CODE	UNIT	DIMENSION	MIN ORDER QTY	PCS/BOX	BOX SIZES	WEIGHT	VOLUME
			NR	NR	L X B X H	KG	M ³
SU136DS590000	CP	-	300	300	BOX01PB 400x300x200	3,30	0,024

TG103A

Terminale

End cap

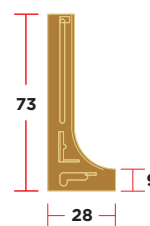
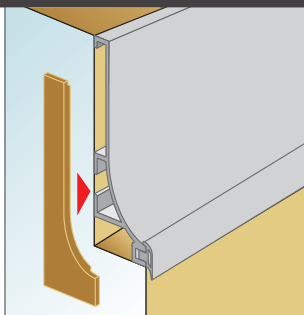

CODE	UNIT	DIMENSION	MIN ORDER QTY	PCS/BOX	BOX SIZES	WEIGHT	VOLUME
			NR	NR	L X B X H	KG	M ³
TG103ADSxx000	CP	-	200	200	-	0,45	-

FG111A

Finale

End cap

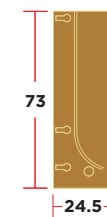
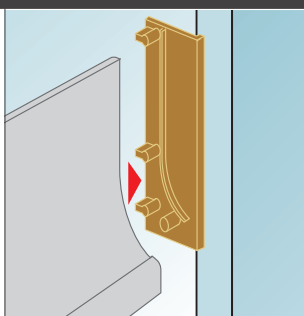

CODE	UNIT	DIMENSION	MIN ORDER QTY	PCS/BOX	BOX SIZES	WEIGHT	VOLUME
			NR	NR	L X B X H	KG	M ³
FG111ADSxx000	CP	-	200	200	-	0,56	-

AG139

Angolo + spigolo

Int/ext corner

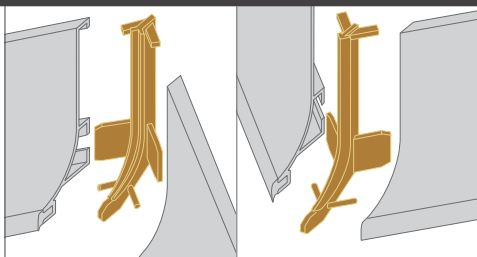

CODE	UNIT	DIMENSION	MIN ORDER QTY	PCS/BOX	BOX SIZES	WEIGHT	VOLUME
			NR	NR	L X B X H	KG	M ³
AG139xx	CP	-	200	200	-	0,46	-