

S6582

STRIKE 37 SMONTATO SENZA VETRO STRIKE 37 PACKED WITHOUT GLASS

Ripiano altezza 37 mm
con sede per vetro o pannello
da 4 mm o 8 mm.
Kit smontato senza ripiano.

37 mm height shelf
with slot for 4 mm or 8 mm
glass or panel.
Kit without glass.

A V

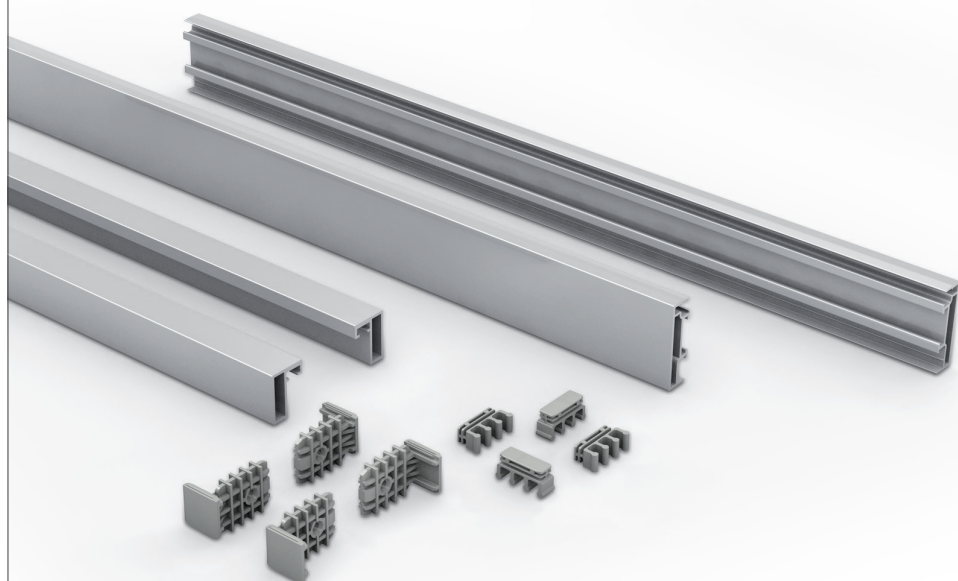

CODE	UNIT	DIMENSION		MIN ORDER QTY	PCS/BOX	BOX SIZES	WEIGHT	VOLUME
		B X H	L					
S6582xxx.001	NR	280x37	450	18	1	470x95x65	0,71	0,003
S6582xxx.002	NR	280x37	600	18	1	620x95x65	0,81	0,004
S6582xxx.005	NR	280x37	900	18	1	920x95x65	0,92	0,006
S6582xxx.007R	NR	280x37	1200	18	1	1220x95x65	2,85	0,008
S6582xxx.008	NR	480x37	450	18	1	470x95x65	0,81	0,003
S6582xxx.009	NR	480x37	600	18	1	620x95x65	0,93	0,004
S6582xxx.012	NR	480x37	900	18	1	920x95x65	1,05	0,006
S6582xxx.014R	NR	480x37	1200	18	1	1220x95x65	2,95	0,008

R6582G

Profilo frontale/posteriore
con guarnizione h. 37 mm. l. 4100 mm.

Front/rear profile
with gasket h.37 mm. l. 4100 mm.

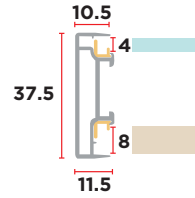
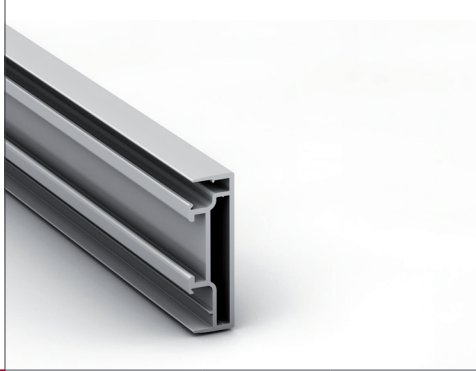

CODE	UNIT	DIMENSION		MIN ORDER QTY	PCS/BOX	BOX SIZES	WEIGHT	VOLUME
		B X H	L					
R6582GxxxL41	ML	11,5x37,5	4100	102,5	25	BOX146 4250x205x80	9,15	0,069

R6581

Profilo laterale

Lateral Profile

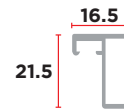
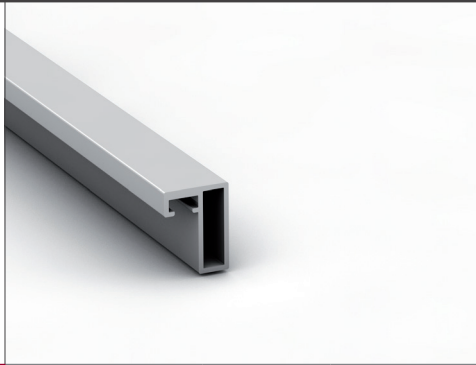

CODE	UNIT	DIMENSION		MIN ORDER QTY	PCS/BOX	BOX SIZES	WEIGHT	VOLUME
		B X H	L					
R6581xxxL41	ML	16,5x22	4100	102,5	25	BOX146 4250x205x80	6,80	0,069

CFT6580/02

Confezione con n. 4 reggipiani

Package of 4pcs. Shelf holder



CODE	UNIT	DIMENSION		MIN ORDER QTY	PCS/BOX	BOX SIZES	WEIGHT	VOLUME
		B X H	L					
CFT6580/02	CF	-	-	-	-	-	-	-

CFT6580/01

Kit giunzioni

Kit splices



CODE	UNIT	DIMENSION		MIN ORDER QTY	PCS/BOX	BOX SIZES	WEIGHT	VOLUME
		B X H	L					
CFT6580/01	CF	-	-	-	-	-	-	-

RAC0300301L3

Profilo in acciaio grezzo L 3000 mm.

Steel profile bar 3000 mm length.

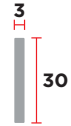
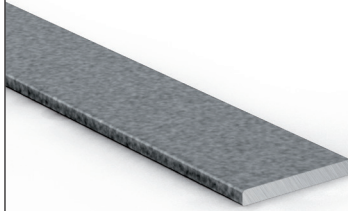

CODE	UNIT	DIMENSION		MIN ORDER QTY	PCS/BOX	BOX SIZES	WEIGHT	VOLUME
		B X H	L					
RAC0300301L3	ML	30x3	3000	-	-	-	-	-

ISTRUZIONI PER IL TAGLIO RIPIANI CUT SHELVES INSTRUCTIONS

LARGHEZZA PROFILO

misura nominale - spessore fianchi - 2 mm

PROFONDITÀ

misura nominale - 23 mm

PROFILE'S WIDTH

nominal measure - sides' thickness - 2mm

DEPTH

nominal measure - 23mm

