

# 282 R270

Piedino base.  
Regolo esterno.

**Regolazione positiva e negativa.**

ABS leg.  
External adjuster.

**Positive and negative tuning.**

**BASE PER FORATURE DA 25 A MAX 32 MM**  
**BASE FOR DRILLINGS FROM 25MM TO 32MM**

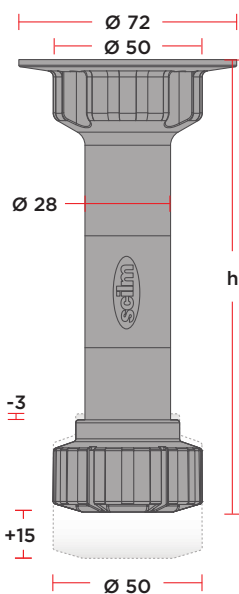
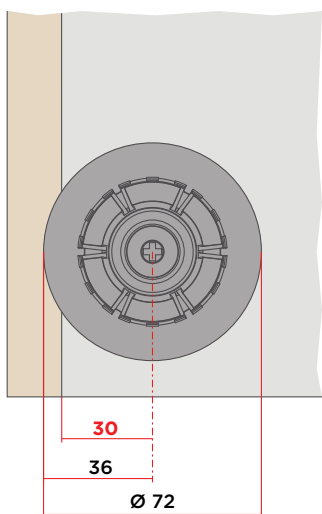

CODE	UNIT	DIMENSION	MIN ORDER QTY	PCS/BOX	BOX SIZES	WEIGHT	VOLUME
		H	NR	NR	L X B X H	KG	M <sup>3</sup>
<b>282R27010SF</b>	NR	100	180	180	BOX57PB 500X400X300	11,82	0,06
<b>282R27012SF</b>	NR	120	150	150	BOX57PB 500X400X300	11,29	0,06
<b>282R27015SF</b>	NR	150	130	130	BOX57PB 500X400X300	11,10	0,06

# BI6406SF

Boccola innesto filettata D15 nera  
 Bush D15 loose black

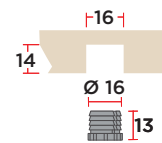

CODE	UNIT	DIMENSION	MIN ORDER QTY	PCS/BOX	BOX SIZES	WEIGHT	VOLUME
		H	NR	NR	L X B X H	KG	M <sup>3</sup>
<b>BI6406SF</b>	NR	-	6000	6000	BOX01PB 400X300X200	9,77	0,024

# PR10MA-C28

Prigioniero M10x28 zincato con collarino  
 Zinc-plated bolt M10x28

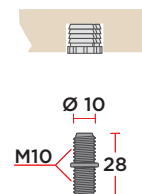
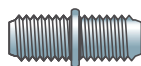

CODE	UNIT	DIMENSION	MIN ORDER QTY	PCS/BOX	BOX SIZES	WEIGHT	VOLUME
		H	NR	NR	L X B X H	KG	M <sup>3</sup>
<b>PR10MA-C28</b>	NR	-	1500	1500	-	26,00	-

# VPKZ

Vite M10x32 TCP zincata  
 M10x32 TCP zinc-plated screw

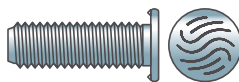

CODE	UNIT	DIMENSION	MIN ORDER QTY	PCS/BOX	BOX SIZES	WEIGHT	VOLUME
		H	NR	NR	L X B X H	KG	M <sup>3</sup>
<b>VPKZ</b>	NR	-	1000	1000	-	28,50	-

# VPF

Vite forata M10x33 TC 16 zincata  
 Drilled screw M10x33 TC 16 zinc-plated

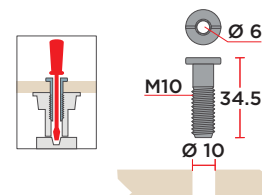
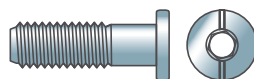

CODE	UNIT	DIMENSION	MIN ORDER QTY	PCS/BOX	BOX SIZES	WEIGHT	VOLUME
		H	NR	NR	L X B X H	KG	M <sup>3</sup>
<b>VPF</b>	NR	-	1000	1000	-	12,00	-

# CF

Copriforo / Screw caps

- bianco  
white
- marrone  
brown
- tanganica  
tanganica
- nero  
black



CODE	UNIT	DIMENSION	MIN ORDER QTY	PCS/BOX	BOX SIZES	WEIGHT	VOLUME
		H	NR	NR	L X B X H	KG	M <sup>3</sup>
<b>CFX0000000000</b>	NR	-	-	-	-	-	-