

232 R28C

Piedino base,
con regolo esagonale.

Regolazione interna ed esterna.

Pvc leg
with hexagonal adjustment.

**Internal and external adjustment
is possible.**

SI ABBINA CON I GANCI ZOCCOLO: GZR54 E GZR58

IT CAN BE USED WITH THE ART. GZR54
AND THE ART GZR58 CLIPS FOR PLINTH

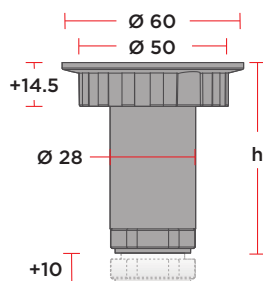
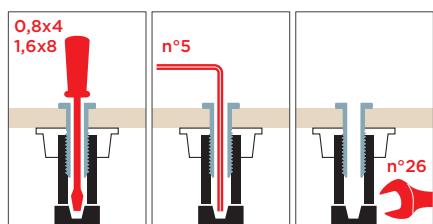
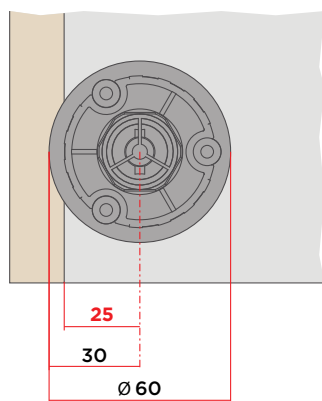

CODE	UNIT	DIMENSION	MIN ORDER QTY	PCS/BOX	BOX SIZES	WEIGHT	VOLUME
		H					
232R28C05SF	NR	55	500	500	BOX57PB 500X400X300	25,00	0,06
232R28C06SF	NR	65	450	450	BOX57PB 500X400X300	23,00	0,06

BI6406SF

Boccola innesto filettata D15 nera
 Bush D15 loose black

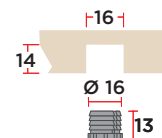

CODE	UNIT	DIMENSION	MIN ORDER QTY	PCS/BOX	BOX SIZES	WEIGHT	VOLUME
		H	NR	NR	L X B X H	KG	M ³
BI6406SF	NR	-	6000	6000	BOX01PB 400X300X200	9,77	0,024

PR10MA-C28

Prigioniero M10x28 zincato con collarino
 Zinc-plated bolt M10x28

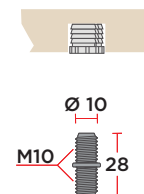
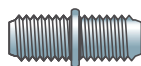

CODE	UNIT	DIMENSION	MIN ORDER QTY	PCS/BOX	BOX SIZES	WEIGHT	VOLUME
		H	NR	NR	L X B X H	KG	M ³
PR10MA-C28	NR	-	1500	1500	-	26,00	-

VPKZ

Vite M10x32 TCP zincata
 M10x32 TCP zinc-plated screw

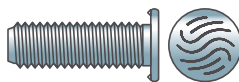

CODE	UNIT	DIMENSION	MIN ORDER QTY	PCS/BOX	BOX SIZES	WEIGHT	VOLUME
		H	NR	NR	L X B X H	KG	M ³
VPKZ	NR	-	1000	1000	-	28,50	-

VPF

Vite forata M10x33 TC 16 zincata
 Drilled screw M10x33 TC 16 zinc-plated

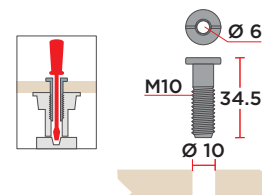
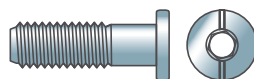

CODE	UNIT	DIMENSION	MIN ORDER QTY	PCS/BOX	BOX SIZES	WEIGHT	VOLUME
		H	NR	NR	L X B X H	KG	M ³
VPF	NR	-	1000	1000	-	12,00	-

CF

Copriforo / Screw caps

- bianco
white
- marrone
brown
- tanganica
tanganica
- nero
black



CODE	UNIT	DIMENSION	MIN ORDER QTY	PCS/BOX	BOX SIZES	WEIGHT	VOLUME
		H	NR	NR	L X B X H	KG	M ³
CFX0000000000	NR	-	-	-	-	-	-