

PROJECT2 55X31 PROJECT2 55x31

ASSEMBLAGGIO STRUTTURA 55X31

55X31 STRUCTURE ASSEMBLY

SOLUZIONE A
SOLUTION A

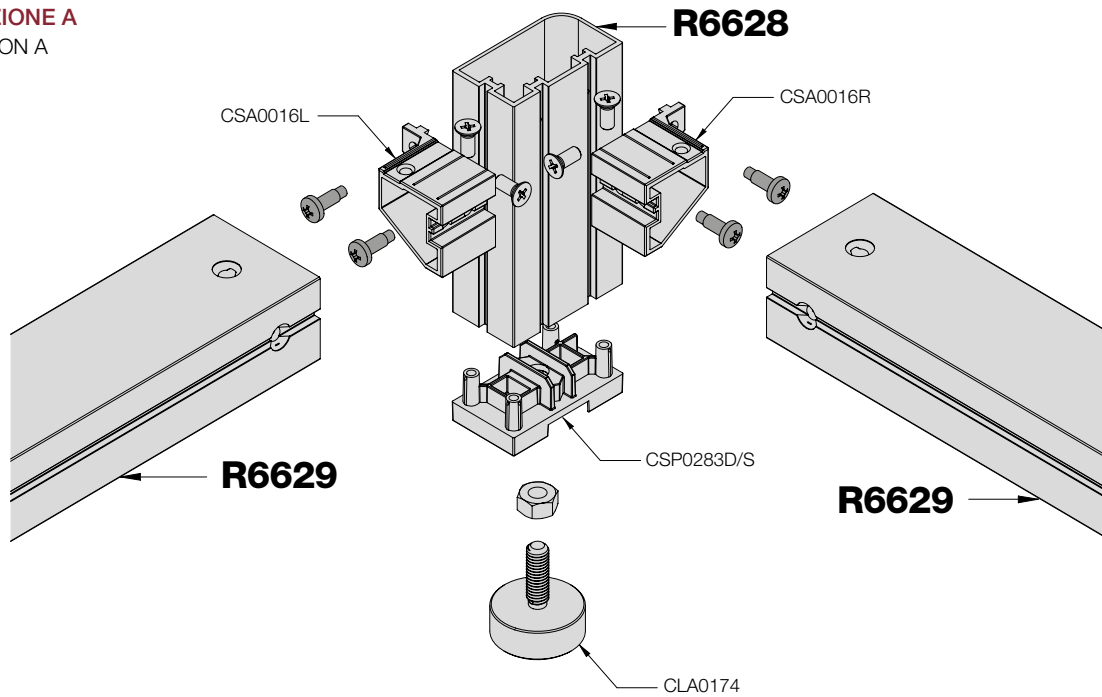

SOLUZIONE B
SOLUTION B

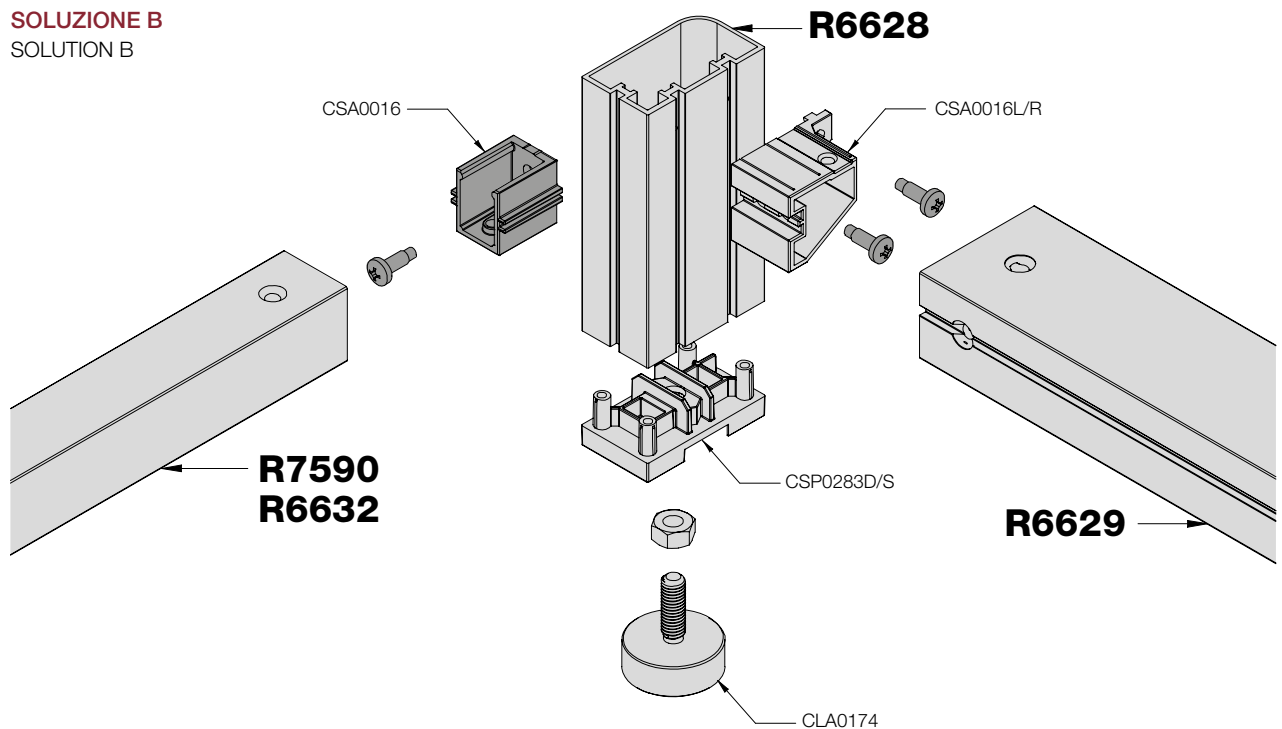

R6628

Profilo montante 55x31
Upright 55x31

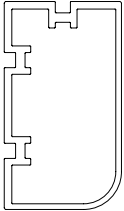

R6629

Profilo traverso
Crossbeam

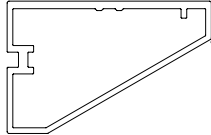

R6630

Profilo montante di rinforzo 31x31
Reinforcing upright 31x31

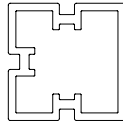

R7590

Profilo traverso 30x30
Crossbeam 30x30

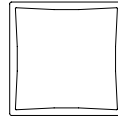

R6632

Profilo traverso 30x30
Crossbeam 30x30

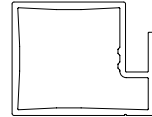

CSP0283D

Tappo portapiedino
Leg cover

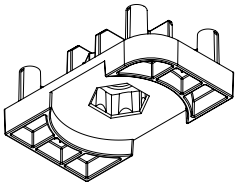

CSA0016R

Blocchetto per struttura 55x31
Joint for 55x31

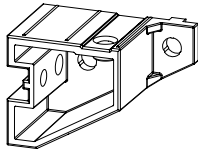

CSP0284

Tappo portapiedino
Leg cover

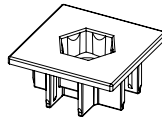

CSA0017

Blocchetto per struttura 30x30 art. R6630, R6632 e R7590
Joint for 30x30 art. R6630, R6632 and R7590

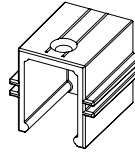

CSP0283S

Tappo portapiedino
Leg cover

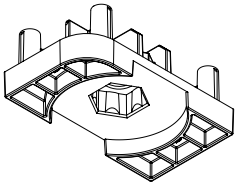

CSA0016L

Blocchetto per struttura 55x31
Joint for 55x31

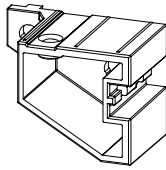

CLA0174

Regolo in alluminio per strutture
Aluminium adjuster for structure

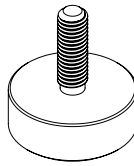

CLA0174

Regolo in alluminio per strutture
Aluminium adjuster for structure

